

TALO MINI WALL 21

TALO WALL 90-120-150-180-240

NEIL POULTON • 2002

WALL MOUNTED LUMINAIRES FOR DIRECT/INDIRECT ENERGY SAVING, HIGH EFFICIENCY FLUORESCENT LIGHTING (ALSO HALOGEN LIGHTING, LIMITED TO THE MINI WALL MODEL) AVAILABLE LENGTHS:

9", 36", 48", 60", 71", 95"

- BODY WITH PROFILES IN EXTRUDED ALUMINUM AND END CAPS IN DIE-CAST ALUMINUM
- AVAILABLE IN WHITE OR SILVER GREY EPOXY POWDER COATING FINISH
- TALO MINI WALL 21 ALSO AVAILABE IN BRILLIANT CHROME FINISH
- UPPER DIFFUSER IN CLEAR MOLDED POLYCARBONATE, LOWER DIFFUSER IN OPALINE MOLDED POLYCARBONATE
- WALL SUPPORTING PLATE IN STEEL, MOUNTING TO STANDARD ELECTRICAL JUNCTION BOXES, WITH ADDITIONAL CONCEALED BODY WALL FASTENING REQUIRED FOR LONGER MODELS

HIGH OUTPUT FLUORESCENT SOURCE

TALO MINI WALL 21 (9")

- 1 X 18W (G24q2/T4) 

TALO WALL 90 (36")

- 1 X 39W (G5/T5/HO) 

TALO WALL 120 (48")

- 1 X 54W (G5/T5/HO) 

TALO WALL 150 (60")

- 1 X 80W (G5/T5/HO) 

TALO WALL 180 (71")

- 2 X 39W (G5/T5/HO) 

TALO WALL 240 (95")

- 2 X 54W (G5/T5/HO) 

HALOGEN SOURCE

TALO MINI WALL 21 (9")

- 1 X 150W (R7s/T3) 



TALO MINI WALL 21 HAL



TALO MINI WALL 21 FLU

unica
HOME

www.unicahome.com
1-888-89-UNICA

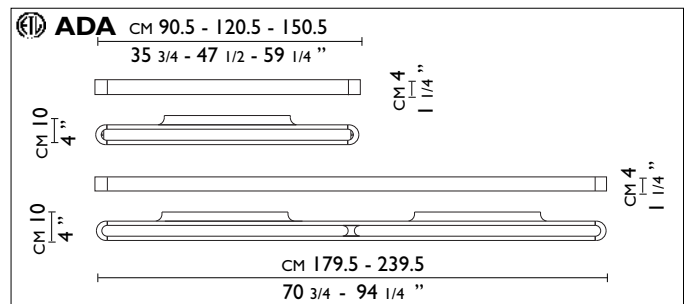
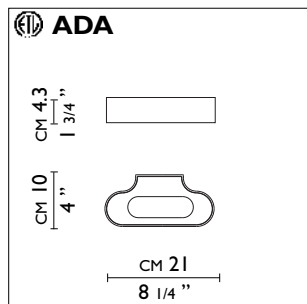
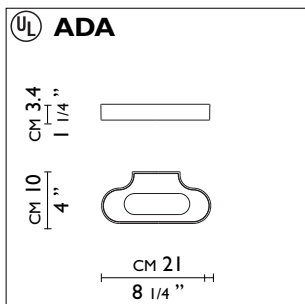



TALO WALL 90



www.unicahome.com
1-888-89-UNICA



TALO WALL 180